

TECHNICAL GASES



EXTREME CONDITIONS - SAFE SOLUTIONS

Safety valves and fittings for technical gases, hydrogen and cryogenic applications.

WHAT SETS GOETZE AND THEIR TECHNICAL GASES PRODUCTS APART



THE NEW DEFINITION OF HIGH-END! UP TO 1500 BAR!

With a truly big bang, Goetze KG breaks through the valve sound barrier. Through the further development of the existing series 492, pressures of up to 1500 bar are safeguarded in the DN6 version. At the same time, the Goetze safety valve is only half the weight and half the size of comparable valves.



INDIVIDUALITY

Our expertise enables us to implement new and custom-made developments in a short time. All valves are produced under premise of „individuality for more safety.“ In product development, individual custom-made solutions go hand-in-hand with our own new developments. This combined pool of development has now given rise to an extensive and high-quality range of products which is being continuously extended and leaves nothing to be desired.



SHORT DELIVERY TIMES AROUND THE GLOBE

Whether safety valves, overflow valves, ball diverter valves, pressure regulators, shut-off valves or other products from our range: you will benefit from the short global delivery times for all our products. All orders can generally be processed within 3-5 working days. You're in a hurry? Then use our express production and your order can be ready for dispatch within 48 hours.



OIL AND GREASE-FREE PROCESS

All components of the series are specially cleaned during the production process and are thus generally free from oil and grease in accordance with DIN EN ISO 23208 and various works standards of gas producers. Because of this every valve is suitable for use in systems using oxygen and is marked accordingly.



HIGH STANDARDS

Not only the products but also the raw materials used must meet the highest standards. The materials are examined by trained personnel as soon as they arrive, in order to ensure the best quality from the very beginning. After production, every individual valve is subjected to an ISO-certified quality control test before it is allowed to leave the factory.

TECHNICAL BASICS FOR TECHNICAL GASES PRODUCTS

Materials

STAINLESS STEEL



- high-quality material
- corrosion-resistant
- for plants with particularly aggressive media

GUNMETAL



- robust and of high quality
- wide range of applications

BRASS

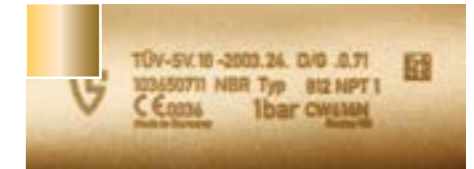

- good price/performance ratio
- brass turned from solid material

Media

LIQUIDS

from -255°C to +400°C

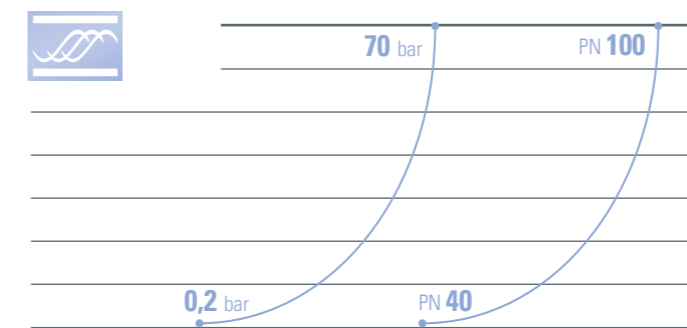

- Storage of cryogenic liquefied gases
- Medical supply systems
- Foodstuff and Pharmaceutical
- Welding shops
- Cooling circuits

AIR, GASES AND VAPOURS

from -255°C to +400°C

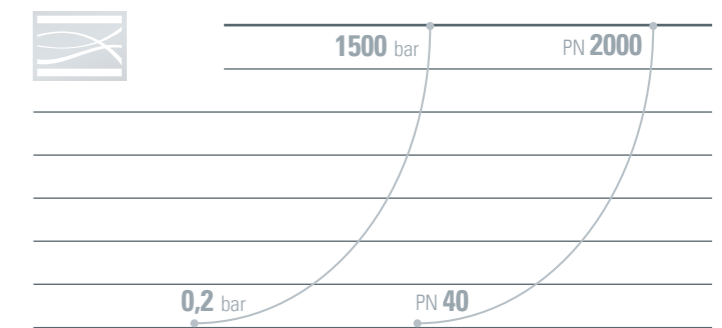

- Refrigeration plants
- Dry ice blasting plants
- H2 storage and refuelling systems
- Electrolysis
- Compressors

Connections



OUR CERTIFICATES

We rely on quality – nationally and internationally

CE Certification according to the European Pressure Equipment Directive is mandatory for many products and markets. Additional certificates are however proof of our individual quality, such as: TÜV, DVGW, WRAS, ACS, EAC. Last but not least, DIN ISO 9001 stands for the internal quality management process, with its comprehensive functionality and performance assessment. The particularly strict regulations of the national rules guarantee the highest possible degree of safety – especially when it comes to the reliability of your plant.

OVERVIEW OF PRODUCTS FOR TECHNICAL GASES APPLICATIONS

Series	National Type Test (TUV)	CE 2014/68/EU	EU Type Examination		CRN	EAC	TS			ABS			RIA
HYDROGEN VALVES													
492	■	■	■	■	■	■	■	■	■	■	■	■	■
2400	■	■	■	■	■	■	■	■	■	■	■	■	■
455	■	■	■	■	■	■	■	■	■	■	■	■	■
420	■	■	■	■	■	■	■	■	■	■	■	■	■
451	■	■	■	■	■	■	■	■	■	■	■	■	■
484/684		■	■			■				■	■	■	■
9000/9040						■							
OXYGEN VALVES													
492GOX	■	■		■		■		■					
CRYOGENIC VALVES													
2400	■	■	■	■	■	■	■	■	■	■	■	■	■
2480	■	■	■	■	■	■	■	■	■	■	■	■	■
2580		■				■							
2140	■	■	■			■							■
2142/2182		■	■			■							
2143/2183		■	■			■							
2180	■	■	■			■							■
2700						■							■
2780/2782						■							
2781/2783						■							■
2980		■				■							■

QUICKFINDER VALVES

Series	Materials	Medium								Temperature in °C											Set pressure bar	
		neutral				non neutral																
		liquid	air/gases	potable water cold	potable water hot	liquid	air/gases	potable water cold	potable water hot													
HYDROGEN VALVES																						
492										[Temperature Range]											[Set Pressure]	
2400		■	■			■	■			[Temperature Range]											[Set Pressure]	
455		■	■			■	■			[Temperature Range]											[Set Pressure]	
420		■	■			■	■			[Temperature Range]											[Set Pressure]	
451		■	■			■	■			[Temperature Range]											[Set Pressure]	
484		■	■			■	■			[Temperature Range]											[Set Pressure]	
9000/9040				■	■			■	■	[Temperature Range]											[Set Pressure]	
OXYGEN VALVES																						
492GOX										[Temperature Range]											[Set Pressure]	
CRYOGENIC VALVES																						
2400		■	■			■	■			[Temperature Range]											[Set Pressure]	
2480		■	■			■	■			[Temperature Range]											[Set Pressure]	
2580										[Temperature Range]											[Set Pressure]	
2140		■	■			■	■			[Temperature Range]											PN 63	
2142		■	■			■	■			[Temperature Range]											PN 63	
2143		■	■			■	■			[Temperature Range]											PN 63	
2180		■	■			■	■			[Temperature Range]											PN 63	
2182		■	■			■	■			[Temperature Range]											PN 63	
2183		■	■			■	■			[Temperature Range]											PN 63	
2700		■	■			■	■			[Temperature Range]											PN 63	
2780/2782		■	■			■	■			[Temperature Range]											PN 63	
2781/2783		■	■			■	■			[Temperature Range]											PN 63	
2980		■	■			■	■			[Temperature Range]											PN 40	

HYDROGEN

Multiple energy source for the future

The industry for electricity generation is facing challenges to find green and sustainable resources and ways to produce electricity and so are engineers and companies for sustainable and green mobility concepts.

The production of hydrogen is already possible by using fossil fuels. But recently innovative processes are becoming more common, like electrolysis. In this case water is split into hydrogen and oxygen. If the required electricity for this process comes from renewable sources, the hydrogen is defined as green. This process for gaining a source of energy and a potential storage method for electricity (as the process can be reversed) makes it innovative in general and also for future mobility. One thing is clear: green energy is the future.

In this field Goetze is your partner regarding safety (valves). We assure the handling of hydrogen from the retrieval to the application – either in the electric part of the process or at the hydrogen filling station for the fuel cell vehicle. We protect filling processes, which are under high pressure or the storage of liquid hydrogen in tanks. This has a major impact on safe handling and makes hydrogen more appealing to humans and nature.



HYDROGEN FILLING STATION IN STUTT GART



HYDROGEN RESEARCH CENTRE



HYDROGEN FUEL PUMPS



PIPES ON A HYDROGEN TANK



ELECTROLYSIS SYSTEM

SAFETY IN HYDROGEN APPLICATIONS

As the last mechanical component in the chain of safety, safety valves are an important and indispensable part of hydrogen applications. It is therefore even more important that every component of a safety valve, as well as the manufacturing process, have specific properties.

MATERIALS

The use of high quality stainless steels. Austenitic steels with a nickel content > 10% have proven to be effective.

SEALS

Pressure, temperature, permeation (diffusion) play an important role here. The elastomer sealing materials which comply with the NORSOK M-710 standard, are prepared against explosive decompression in the material and prevent the loss of the seal.

MANUFACTURING PROCESS

Do you place high standards on the cleanliness of your system components? In addition to the production which is free of oil, grease and particle, which is explicitly recommended for a hydrogen purity of > 5.0 (> 99.999 %).

APPROVALS

Even if there are currently no specific H2 approvals, only use type-test approved safety valves to protect your systems.

Sound technical advice from the valve manufacturer is in any case indispensable. This is the only way to take your specific conditions into account and to design the valve correctly according to the conditions prevailing on site. Our technical experts will be happy to help you - quickly and reliably: **+49 (0) 7141 / 488 94 60.**

SAFETY VALVES AND FITTINGS FOR HYDROGEN APPLICATIONS

Materials



Temperatures
from -255 °C to +400 °C



Pressures
from 0,2 bar to 1500 bar

Media



Threaded connections
from ¼" to 2"



Flange connections
from DN 15 to DN 100



Goetze also has a wide portfolio of safety valves and pressure reducers for the hydrogen sector in the non-cryogenic area. The products on the following page are examples of this. In particular, gas applications in the high-pressure range and gas pressure control systems in a wide variety of applications are always in focus. Oxygen also plays a special role, whether in electrolysis or storage.

GOETZE VALVES FOR GAS APPLICATIONS ARE USED HERE:



Safety valves and fittings for hydrogen applications

SAFETY VALVES SERIES 492

made of stainless steel, with gas-tight, 360° rotatable outlet



The Series 492 atmospheric discharge safety valve with rotatable outlet body is used in the field of high-pressure compressors and process plants and to protect refuelling systems.

It convinces through its compactness and design.

Due to its special technical construction and design the series covers a pressure range that has not been catered for up to now.

The valve is particularly suitable for hydrogen, high-performance materials such as PAI or PEEK allow a very high tightness. A very high level of tightness can be ensured even after multiple responses.

SAFETY VALVES SERIES 451

made of stainless steel, angle-type, with threaded connections



In processes with lower volumes and low pressures, such as hydrogen production or the electrolysis process, the protection must still be reliable.

The advantages and applications of Series 451 made of high-grade stainless steel begin, where versions made of gunmetal are at their limits. The flexibility of the various versions guarantee an optimal configuration for every application.

In addition to the basic version the numerous sealing possibilities and materials, back-pressure compensating metal bellows and / or a gastight cap offer the necessary optional extras required to fulfill the highest safety requirements.

SAFETY VALVES SERIES 420

made of stainless steel, angle-type, with threaded connections



For supporting the hydrogen generation and electrolysis processes, reliable safety valves are required which can also handle low flow-volumes and pressures.

Thanks to TÜV and European approvals, the miniature safety valve series 420 allow use in applications for neutral and non-neutral gaseous and liquid media.

The cutting ring threaded connections available as an option make this valve quick and easy to install for use in small pipelines.

SAFETY VALVES SERIES 2400

made of stainless steel, angle-type, with threaded connections



Cryogenic valves must meet special requirements to provide reliable protection, for example in tanks and filling systems for cryogenic liquid gas. The Series 2400 safety valve therefore got fully approved for vapours and gases as well as for liquids according to ISO 4126-1 and ASME Code Sec. VIII Div. 1.

All components of the valve are specially cleaned during the production process and are thus oil- and grease free in accordance with DIN EN ISO 23208. Because of this, every valve is suitable for use in systems using oxygen and is marked accordingly.

The use of 1.4404 and 1.4408 high-grade stainless steels render the safety valves particularly resistant to extremely cold temperatures. For use with gases that are in contact with food an FDA-compliant sealing material is used.

SAFETY VALVES SERIES 455

made of stainless steel, angle-type, with flange connections



For applications with large volumes our 455 is the valve to choose.

Often, flange connections are required for installation in existing piping systems.

Goetze has taken great care to achieve high performance for all sizes of the series 455, this is unique in the field of flange safety-valves in general.

By using exclusively high-quality materials with outstanding media resistance and the option to protect the tightness towards the atmosphere on a high level with back-pressure compensating bellows, this safety valve is suitable for nearly any applications.

The pressure range covers 0,2 to 40 bar and the temperature range up to +400° Celsius permits employment in a wide temperature range.

PRESSURE REDUCING VALVES SERIES 484

made of stainless steel, with female threaded connections



These diaphragm or piston pressure reducing valves made of stainless steel and with female threaded connections for pneumatic and hydraulic applications are distinguished particularly by high flow rates and low pressure losses even in situations of high performance demands.

The fully balanced and thus compensating valve is available with and without secondary venting as a diaphragm or piston version.

The pressure is adjusted without tools via the ergonomically shaped handwheel.

The extremely small pressure loss in the control operating range makes this high-performance pressure reducer unrivalled.

 **Temperatures**
from -60 °C to +200 °C

 **Pressures**
from 50 bar to 1500 bar

 **Threaded connections**
from ¼" to 1"



Data sheet

 **Temperatures**
from -60 °C to +400 °C

 **Pressures**
from 0,5 bar to 70 bar

 **Threaded connections**
from ½" to 2"



Data sheet

 **Temperatures**
from -40 °C to +260 °C

 **Pressures**
from 0,5 bar to 50 bar

 **Threaded connections**
from ¼" to ¾"



Data sheet

 **Temperatures**
from -200 °C to +200 °C

 **Pressures**
from 0,2 bar to 70 bar

 **Threaded connections**
from ¼" to 1½"



Data sheet

 **Temperatures**
from -255 °C to +400 °C

 **Pressures**
from 0,2 bar to 40 bar

 **Flange connections**
from DN 15 to DN 100



Data sheet

 **Temperatures**
from -40 °C to +120 °C

 **Inlet pressure** up to 60 bar,
Outlet pressure adjustable
from 0,5 bar to 50 bar

 **Threaded connections**
from ¼" to 2"



Data sheet

HIGH PRESSURE SAFETY VALVES FOR OXYGEN APPLICATIONS

Materials



Media



Temperatures
from -40 °C to +60 °C



Pressures
from 50 bar to 420 bar



Threaded connections
from 1/4" to 3/4"

SAFETY VALVES SERIES 492GOX

made of brass,
with threaded connections



With increasing pressures and/or temperatures in oxygen applications, the risk of fire also increases. Due to the fire-promoting effect of oxygen, the ignition temperature of materials is significantly reduced. As a result, materials that are not combustible under normal ambient conditions are now completely burnt under the effect of the oxygen. At high pressures, pressure surges can cause very high temperatures. These significantly exceed the ignition temperature of metallic materials, which is lower under the influence of oxygen and can lead to catastrophic fires. For critical applications of this kind, Goetze has developed a suitable and safe solution with the 492GOX series. Here, the pressure-bearing parts have been replaced by correspondingly safe materials such as monel and brass.

Safety valves which are specially used for applications with oxygen are needed in many industries. Particularly in the production of technical gases, medical gases and manufacturers of compressors, components and industrial construction companies.

Due to the special requirements for high-pressure oxygen, the 492GOX safety valve has components made of monel to reliably prevent oxygen burnout. Additionally the 492GOX safety valve is subjected to a special oxygen pressure surge test. The compact design and the rotatable outlet with threaded connection, which allows the valve to be positioned in the desired blow-out direction even after installation, make the 492GOX safety valve an innovative addition to the product portfolio.

GOETZE VALVES FOR OXYGEN APPLICATIONS ARE USED HERE:



Production of industrial gases



O2 injection in steel production



Temperatures
from -40 °C to +60 °C



Pressures
from 50 bar to 420 bar



Threaded connections
from 1/4" to 3/4"



Data sheet

Production process Purified Gases

In many areas of the application of technical gases, particularly high demands are placed on the purity of the gases and on the fittings in use.

They are used above all in the production of technical and medical gases, for hydrogen in fuel cells, by compressor manufacturers and plant constructors. manufacturers and plant constructors.

The handling of high-purity gases requires extreme care throughout the entire production process. This is the only way to avoid hazards in the application. In order to meet these high standards, Goetze has a production process (**Purified Gases**) specially designed for high-purity gases.

PRODUCTION PROCESS:

Receipt of the enquiry followed by a technical check by our sales department whether the sealing materials and lubricants are suitable for the pressures and temperatures required in the application.

For critical gases, such as oxygen and hydrogen, compliance with essential processes is necessary. In the area of oxygen applications, it is necessary to use sealing materials that have been tested by the Federal Institute for Materials Testing (BAM) for this specific application. In applications with hydrogen, there are also requirements for the purity (e.g. in fuel cell systems) of the gas and thus for the components, as well as for the properties of the sealing materials to be used (Norsok Standard M-710 for o-rings).

Cleaning of the individual parts with specific solvents and ultrasound. The individual parts are then packed in closed transport boxes.

The assembly, testing, packaging and labelling of the valves is carried out at our own assembly stations. These steps serve the purpose of achieving corresponding limit values of hydrocarbon compounds and particle impurities.

- Limit value for hydrocarbon impurities: $\leq 100 \text{ mg/m}^3$
- Limit value for particle impurities: $\leq 100 \mu\text{m}$

Dispatch of the valves to the customer.

Professionally trained personnel, compliance with all relevant regulations and recurring processes, monitoring of the cleaning which is free of oil, grease and particles, assembly, testing, packaging and labelling guarantee customers a valve which conforms to high-purity gas standards for their applications.



Separate assembly area for valves in high purity gas applications

EVERYTHING FROM A SINGLE SOURCE

Goetze valves in combination

Protect, Shut-off, Control or Divert – with the products for cryogenic applications from Goetze KG Armaturen you can source everything from one single supplier. Goetze is also your partner when it comes to the subject of safety. With our cryogenic valve package we guarantee safe installations and storage tanks.

The stable functioning of a safety valve is not only affected by the amount of medium which has to be relieved, but also it is just as important to take into account the pressure losses prevailing in the inlet piping. According to standard regulations the pressure loss in the inlet piping should not be more than 3%. Due to the length of the inlet piping involved, this safety-relevant requirement plays an important role in particular in the protection of vessels used for the storage of cryogenic liquefied gases.

This is where the diverter ball valve **series 2700/2780** in combination with the **series 2400/2480** comes into play. The flow channels of the diverter ball valve have been optimised in their design. This results in high flow capacities and reduced pressure drops in the inlet piping to the safety valves combined with a stable functioning. Furthermore, the various connection options available for the diverter ball valve make diverse protection measures possible. For example by means of parallel fitted bursting disc.

Several different valves are required due to the varying operating conditions of the tank installations, whether product discharge is a gaseous and or liquid state, filling of the tank during the gaseous or liquid phase, or in case of maintenance, different valves are required. The new shut-off valve **series 2140/2180** is tailor-made for this purpose and designed according to DIN EN1626 for applications in cryogenic plants. The straight-through design valve consists of a flow-optimised valve body made either of high-quality stainless steel 1.4409 or lead content reduced gunmetal CC499K. Depending on the application environment three different valve drive options are available. Highest tightness requirements are guaranteed by means of a self-adjusting PTFE spindle seal integrated into the valve housing.

Operation of the adjustment mechanism is carried-out by means of a high-quality stainless steel hand-wheel, which is fitted with an optical

position indicator on its underside. By means of this feature the operator can easily see the exact position of the valve at a glance, which guarantees extra safety in the handling of cryogenic media.

To protect against the unintentional backflow of gases or liquids, the shut-off valve can be designed with a non-return function; alternatively the non-return valves of the **2142/2182** series can be provided.

The high cleanliness requirements are ensured by installing strainers of the **2143/2183** series, thus preventing contamination in the medium and in the downstream process. The strainers can be equipped with different mesh sizes.

Constant pressure in the storage tank is guaranteed by means of the pressure regulator **series 2980**. The required tank pressure is set on the regulator by means of an integrated adjustment screw. Depending on the spring combination fitted, a set pressure between 2 and 38 bar is possible.

During product discharge the main function of the pressure regulator is as a pressure booster. If the valve disc is lifted the vessel pressure is increased and held constant at the set level.

A further function of the regulator is as an overflow valve which enables excess pressure to be released. A pressure increase resulting from temperature influences and times of non usage is relieved via the upper connection on the user side. As a result of this, the safety valve will operate and avoid unwanted loss of gas.

Additional protection of the valves and fittings is offered by the safety function. Due to the combination of a valve disc with metal bellows which, in the case of a rise in pressure, opens on the inlet side e.g. due to evaporation of captive liquids. In this way, an equilibrium of pressure between the two other connections is achieved. Due to these combined functions savings on valves and piping can be achieved.

► SAFETY VALVES SERIES 2400/2480

- high blow-off capacity
- compact design
- FDA compliant sealing material
- high-quality materials 1.4404 / C499K

► OVERFLOW VALVE SERIES 2580

- safe discharge of boil off gas
- easy and quick installation and adjustment of the set point with a hexagonal key
- can be sealed to prevent unauthorised adjustment

► SHUT-OFF VALVES SERIES 2140/2180

- straight-through housing with flow-optimised housing geometry
- high Kvs-value
- open / closed position clearly visible via optical position indicator
- manually operated actuator (open & close) via ergonomically designed stainless steel handwheels
- executable with non-return function

► DIVERTER BALL VALVES SERIES 2700/2780/2781/2782/2783

- flow-optimised housing
- separate test connections
- ergonomically shaped handle

► PRESSURE REGULATORS SERIES 2980

- wide setpoint range and simple, convenient mechanical pressure adjustment
- high flow capacity due to bellows control made of high-quality stainless steel
- compatible, market-standard overall length
- standard, integrated fine filter on valve inlet and outlet

► NON-RETURN VALVE SERIES 2142 / 2182

- low opening pressure
- high Kvs-value

► DIRT TRAP SERIES 2143 / 2183

- standard mesh size 250µm
- optional mesh sizes on request



SAFETY VALVES AND FITTINGS FOR CRYOGENIC APPLICATIONS

Materials



Temperatures
from -200 °C to +200 °C



Pressures
from 0,2 bar to 70 bar
PN40, PN63 and PN100

Media



Threaded connections
from ¼" to 1½"



**Welding end /
Welding socket**
DN10 to DN50

The cryogenic valves by Goetze KG are pioneering in their application and can be used in many industries. Low-temperature gases are used in many industries, ranging from food processing, medical equipment down to energy production. The outstanding quality of the new cryogenic valves by Goetze has been confirmed by their approval for use with both gases and vapours – and as well as for liquids.

GOETZE VALVES FOR CRYOGENIC APPLICATIONS ARE USED HERE:



Safety valves and fittings for cryogenic applications

SAFETY VALVES SERIES 2400

made of stainless steel, angle-type,
with threaded connections



The safety valves of this series have been awarded full approval for vapours and gases as well as for liquids, according to ISO 4126-1 and AS ME Code Sec. VIII Div. 1. All components of the valve are specially cleaned during the production process and are thus oil- and grease free in accordance with DIN EN ISO 23208. Because of this every valve is suitable for use in systems using oxygen and is accordingly marked.

The use of 1.4404 and 1.4408 high-alloy stainless steels renders the safety valves particularly resistant to extremely cold temperatures. For the use with gases that are in contact with food an FDA-compliant sealing material has been used. Overpressure from 0,2 bar up to 70 bar is purged safely with a consistently high level of performance.

SAFETY VALVES SERIES 2480

made of gunmetal, angle-type,
with threaded connections



The well proven safety valve series 2400 made of stainless steel has received a variant sister series, type 2480, that is made of gunmetal. This is characterised in particular by the fact that the outlet can be enlarged by one to two nominal widths.

Functionality and performance comply exactly with the sister series and it is just as stable in terms of function and high performance capability. A fundamental requirement for us is that the approvals in accordance with ISO 4126-1 and ASME Code Sec. VIII Div. 1 are also covered.

All valves made of gunmetal are as a matter of course suitable for oxygen use and comply with basically all common delivery requirements of international standards like DIN EN, ASTM, EIGA and CGA as well as the specifications of the gas producers.

OVERFLOW VALVES SERIES 2580

made of gunmetal, angle-type,
with threaded connections

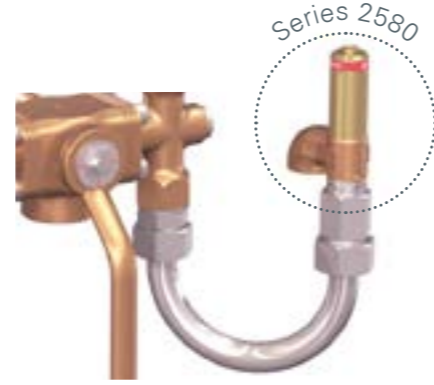

The overflow valve is characterised by the fact that it ensures a continuous and quiet pressure reduction when used on tanks for the storage of cryogenic liquefied technical gases such as argon, oxygen, nitrogen or carbon dioxide.

The overflow valve is adjusted to a pressure below the set pressure of the safety valves and thus prevents the safety valves of the tank from reacting.

Using the overflow valve of type 2580 ensures that the amount of gas that is discharged is no greater than that generated in the tank due to the heat input. When tapping the gas, the valve closes so that no gas is lost unnecessarily. The overflow valve is easily fitted to the lower connections of the diverter ball valve. The connection pipe elbow required for this purpose can be included in the delivery.

SHUT-OFF VALVES SERIES 2140

made of stainless steel,
in straight form



The main function of the 2140 shut-off valve is the controlled opening and closing of pipeline sections via the valve seat integrated in the body.

Due to the use of high-quality materials, the fitting can be used for cryogenic operation at temperatures down to -196°C. The shut-off valves are approved according to DIN EN 1626.

The series is available in the nominal widths DN10 - DN50 and can be designed with connection options for welding ends and welding sockets. The manual valve actuator is operated via an ergonomically shaped handwheel, the open/closed position can be seen at all times via a visual position indicator.

The valve upper section can be configured with three different actuator lengths depending on the application and operating environment.

SHUT-OFF VALVES SERIES 2180

made of gunmetal,
in straight form



The series 2180 is characterised by a corrosion-resistant, lead-reduced gunmetal housing and a stainless steel valve upper section. The design is identical to that of the series 2140 and therefore offers an excellent price-performance ratio.

The valve cone is made of CW617N brass and adapted to the high-quality stainless steel valve spindle. Threaded and soldered sleeve connections are available.

The series also meets the requirements of DIN EN 1626.

NON-RETURN VALVES SERIES 2142/2182

made of stainless steel / of gunmetal,
in straight form



The non-return valves are used in pipelines for the storage, transport and production of liquid gases and provide protection against the unintentional backflow of gases or liquids.

The check valves are used at operating temperatures from -196°C up to +120°C and are available in nominal sizes from DN10 - DN50 and in the pressure range up to 63bar.

The valves can be designed with stainless steel (series 2142) or gunmetal body (series 2182).

 **Temperatures**
from -200 °C to +200 °C

 **Pressures**
from 0,2 bar to 70 bar

 **Threaded connections**
from 1/4" to 2"



Data sheet

 **Temperatures**
from -200 °C to +200 °C

 **Pressures**
from 0,2 bar to 70 bar

 **Threaded connections**
from 1/4" to 1"



Data sheet

 **Temperatures**
from -200 °C to +200 °C

 **Pressures**
from 0,2 bar to 70 bar

 **Threaded connections**
from 1/4" to 1/2"



Data sheet

 **Temperatures**
from -196 °C to +120 °C

 **Pressures**
PN 63

 **Butt weld / Socket weld**
from DN 10 to DN 50



Data sheet

 **Temperatures**
from -196 °C to +120 °C

 **Pressures**
PN 63

 **Thread / Soldering socket**
DN 25, DN 40



Data sheet

 **Temperatures**
from -196 °C to +120 °C

 **Pressures**
PN 63

 **Butt weld / Socket weld
Thread / Soldering socket**
from DN 10 to DN 50



Data sheet



Data sheet

Safety valves and fittings for cryogenic applications

DIVERTER BALL VALVES SERIES 2700

made of stainless steel,
with threaded connections



DIVERTER BALL VALVES SERIES 2780/2782

made of gunmetal,
with threaded connections



DIVERTER BALL VALVES SERIES 2781/2783

made of gunmetal,
with threaded connections



The optimal design of the flow channels within the diverter ball valve enable particularly high flow rates. This significantly reduces flow pressure losses to the safety valves and safe operation remains ensured. The use of 1.4404 and 1.4408 high-alloy stainless steels enables high resistance against internal and external influences.

For the use with gases that are in contact with food an FDA-compliant sealing material has been used. Thanks to the oil- and grease-free manufacturing process, the diverter ball valve are suitable for use in systems using oxygen. With the ergonomically shaped handle and the separate testing connections, the diverter ball valve is optimally prepared for the maintenance of the safety valves.

As already implemented with the stainless steel series 2700, the gunmetal diverter ball valve 2780 possesses a flow geometry with very low pressure loss. The safe functionality of the safety valves mounted on the diverter ball valve is therefore better ensured.

Additionally, opposite to the vertically mounted safety valves, there are also connections for bursting discs available. Due to the consistent cleaning of all component parts, the gunmetal diverter ball valve is also optimally suited for use in systems using oxygen.

Additional connection options are provided for series 2782.

Ball diverter valve for the installation of for example two safety valves in combination with bursting discs for the protection of containers designed for the storage of cryogenic gases.

The requirements of the PED for redundant or different types of safety devices are met with this fitting and in conjunction with the safety valves of the 2400 / 2480 series. Two additional connections for suitable bursting discs are available on each side.

In case of maintenance of the safety valves or replacement of the bursting discs, the side to be maintained is shut off from the tank.

With the series 2783, an extension of the connection options is also available for this type.

PRESSURE REGULATORS SERIES 2980

made of gunmetal,
with pipe or threaded connections



The pressure regulator of the series 2980 is designed for setting and controlling the vessel pressure on tanks used for the storage of cryogenic liquefied gases, such as LIN, LOX, LAr, LNG.

The use of two high-quality stainless steel bellows, the lead-reduced gunmetal body material and the PTFE seat seal make the pressure regulator suitable for a wide temperature range.

The pressure regulator is available in three different spring packages and can be individually adjusted up to 38 bar. The pressure regulator is characterised by temperature resistance and an excellent control quality combined with a compact design.

DIRT TRAP SERIES 2143/2183

made of stainless steel / of gunmetal,
in straight form



The strainers of the 2143 series consist of a straight-through housing made of high-quality stainless steel and, in the case of the 2183 series, of lead-reduced gunmetal.

The strainer unit is integrated between the housing and the cover and can be designed with different mesh sizes.

The installation of the strainer prevents contamination in the medium and in the downstream process.

LOCKING SLEEVE UNIT

made of stainless steel or brass,
angle-type with threaded connections



For simple alignment and positioning of safety valves on the diverter ball valve (DBV). Available in various sizes and materials.

Standard delivery oil- and grease-free with seals made of PTFE with FDA Approval.

 **Temperatures**
from -200 °C to +120 °C

 **Pressures**
PN 63

 **Threaded connections**
from 3/4" to 1 1/4"



Data sheet

 **Temperatures**
from -200 °C to +120 °C

 **Pressures**
PN 63

 **Threaded connections**
from 3/4" to 1 1/4"



Data sheet Data sheet

 **Temperatures**
from -200 °C to +120 °C

 **Pressures**
PN 63

 **Screw connection with
welding end / solder nipple**
DN 25



Data sheet Data sheet

 **Temperatures**
from -196 °C to +200 °C

 **Pressures**
PN 40

 **Threaded connections**
DN 25



Data sheet

 **Temperatures**
from -196 °C to +200 °C

 **Pressures**
PN 63

 **Butt weld / Socket weld
Thread / Soldering socket**
from DN 10 to DN 50



Data sheet Data sheet

Temperatures
from -200 °C to +200 °C

Pressures
PN 100

Threaded connections
from 1/2" to 1"



Data sheet

CONNECTION POSSIBILITIES

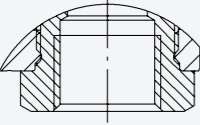
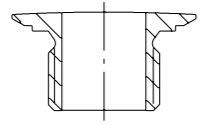
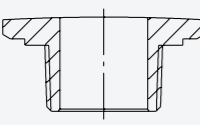
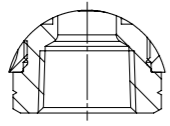
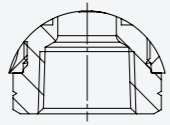
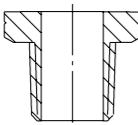
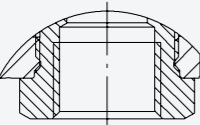
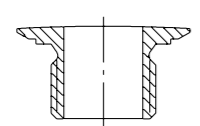
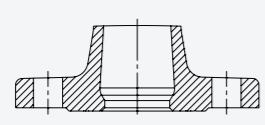
Connection type	Drawing	Description
f		Whitworth male threaded pipe connection cylindrical; seal not made on thread BSP-P according to DIN ISO 228
m		Whitworth male threaded pipe connection cylindrical; seal not made on thread BSP-P according to DIN ISO 228
BSP-Tm		Whitworth male threaded pipe connection tapered; seal made on thread male connection BSP-T according to DIN EN 10226
NPTf		US standard tapered pipe thread NPT female threaded pipe connection NPT according to ANSI / ASME B 1.20.1 seal made on thread
NPTFf		US tapered pipe thread for dry closure NPTF female threaded pipe connection NPTF according to ANSI / ASME B1.20.3 seal made on thread
NPTm		US standard tapered pipe thread NPT male threaded pipe connection NPT according to ANSI / ASME B 1.20.1 seal made on thread
METf		Metric ISO female connection according to DIN 13 seal not made on thread
METm		Metric ISO male connection according to DIN 13 seal not made on thread
FL		Cast flange connection according to DIN EN 1092

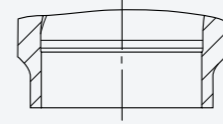
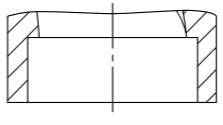
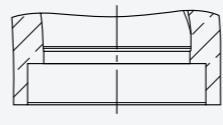
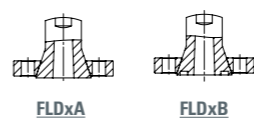
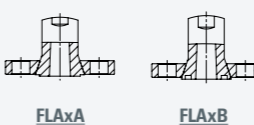
Connection type	Drawing	Description
SE		Welding end SE1 for pipes according to DIN EN ISO 1127 SE2 for pipes according to ASTM A312 S10 SE3 for pipes according to ASTM A312 S40 SE4 for pipes according to DIN 11850 row 2; DIN 11866-A; DIN EN 10357 series A SE5 for pipes according to DIN EN ISO 1127; DIN 11866-B; DIN EN 10357 series C SE6 for pipes according to BS 4825-1; DIN 11866-C
SM		Welding socket SM1 for pipes according to DIN EN ISO 1127 SM2 for pipes according toh ASTM A312 S10 SM3 for pipes according to ASTM A312 S40
LM		Soldering socket LM1 for pipes according to DIN EN ISO 1127 LM2 for pipes according to ASTM A312 S10 LM3 for pipes according to ASTM A312 S40 LM4 for pipes according to DIN EN 12449
FLDxA, FLDxB		Loose flange connection according to DIN EN 1092 up to max. PN 100 x = Pressure rating A = Without sealing groove B = With sealing groove
FLAxA, FLAxB		Loose flange connection according to ASME B 16.5 up to max. 600 lbs x = Pressure rating A = Without sealing groove B = With sealing groove

HOW TO HANDLE PRESSURE

The competence of Goetze KG Armaturen has been in demand for more than 70 years. Our wealth of experience is as broad and varied as our areas of application for our high-performance fittings.

The Goetze product range

500.000 VALVES PER YEAR

out of a wide product portfolio – „Made in Germany“

Our locations

GERMANY, LUDWIGSBURG

CHINA, RUSSIA, UNITED KINGDOM, BRAZIL, USA | SALES DISTRIBUTORS

-255 °C – +400 °C

uncompromising performance

0,2 BAR – 1500 BAR

impressive pressure range

Goetze's concentrated expertise

We support our customers with our many years of experience in this sector at the highest level. Thanks to the expertise of our qualified development team, we are able to continuously develop new and innovative products and adapt to individual customer requirements. Using precise manual work and precision manufacturing, we are able to advance the ideas and product innovations of our customers – customer-focused, solution-oriented, flexible and always in German brand quality.

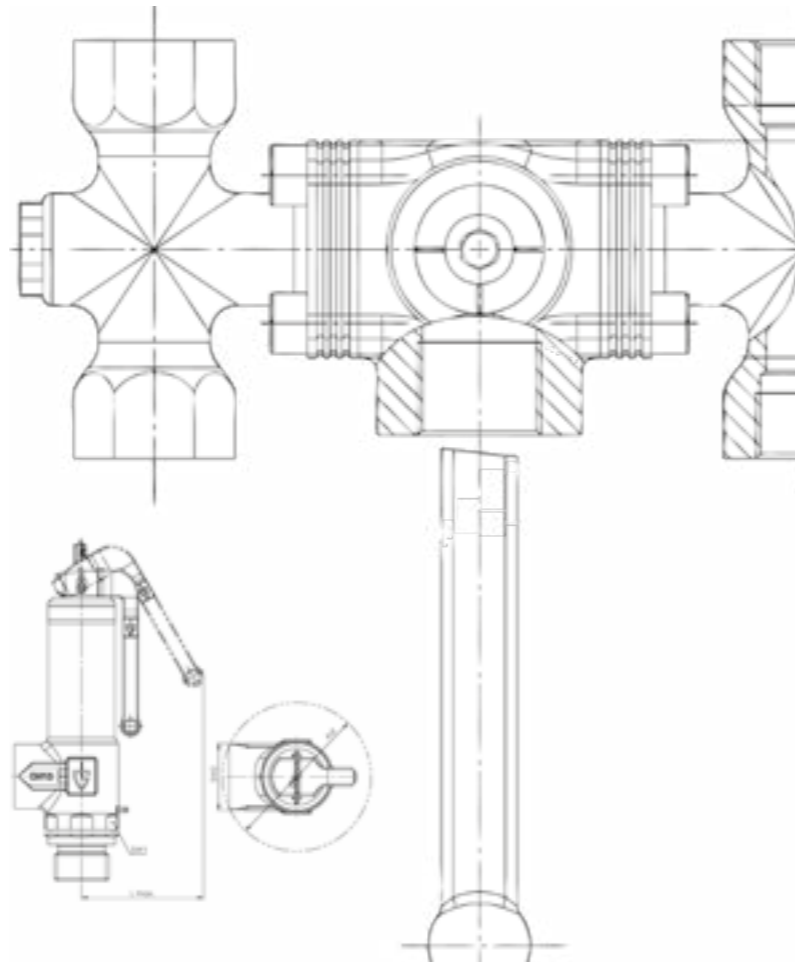

THE GOETZE KG ARMATUREN

Individuality for more safety

The competence of Goetze KG Armaturen has been in demand for 70 years. Our wealth of experience is as broad and varied as our areas of application for our high-performance fittings. Our well thought-out product portfolio covers every industrial application: Liquids of all kinds, gases, technical vapours and steam. Goetze valves are used with temperatures ranging from -255 °C up to +400 °C. The greatest possible safety is a priority.

PROFESSIONAL AND COMPETENT ADVICE

At any time, you can reach a competent contact partner as part of our in-house team at Goetze. Whether it is for the product selection, the configuration of the right valve, urgent requests, whether per telephone call or per mail, there is a personal multilingual consultant at your disposal. With over 500.000 valves per year „Made in Germany“, we are your competent partner for all matters relating to the handling of pressure.

Technical consulting is not only the focus of our in-house team. We provide support for our customers with the necessary information and instructions throughout the entire life cycle of the valve thereby assisting those persons who have to work with the fittings every day. Our field representatives are tasked with providing customers with the best possible consultation service at the customer's facility and supporting them in all questions concerning our products.

GLOBAL TRADE

Goetze products – available worldwide, directly and quickly. No matter whether through Goetze or our trading partners. Our sales subsidiaries and local dealers will always provide the advice you need to find the product that suits you best. Discover our dealer network and find your local dealer.



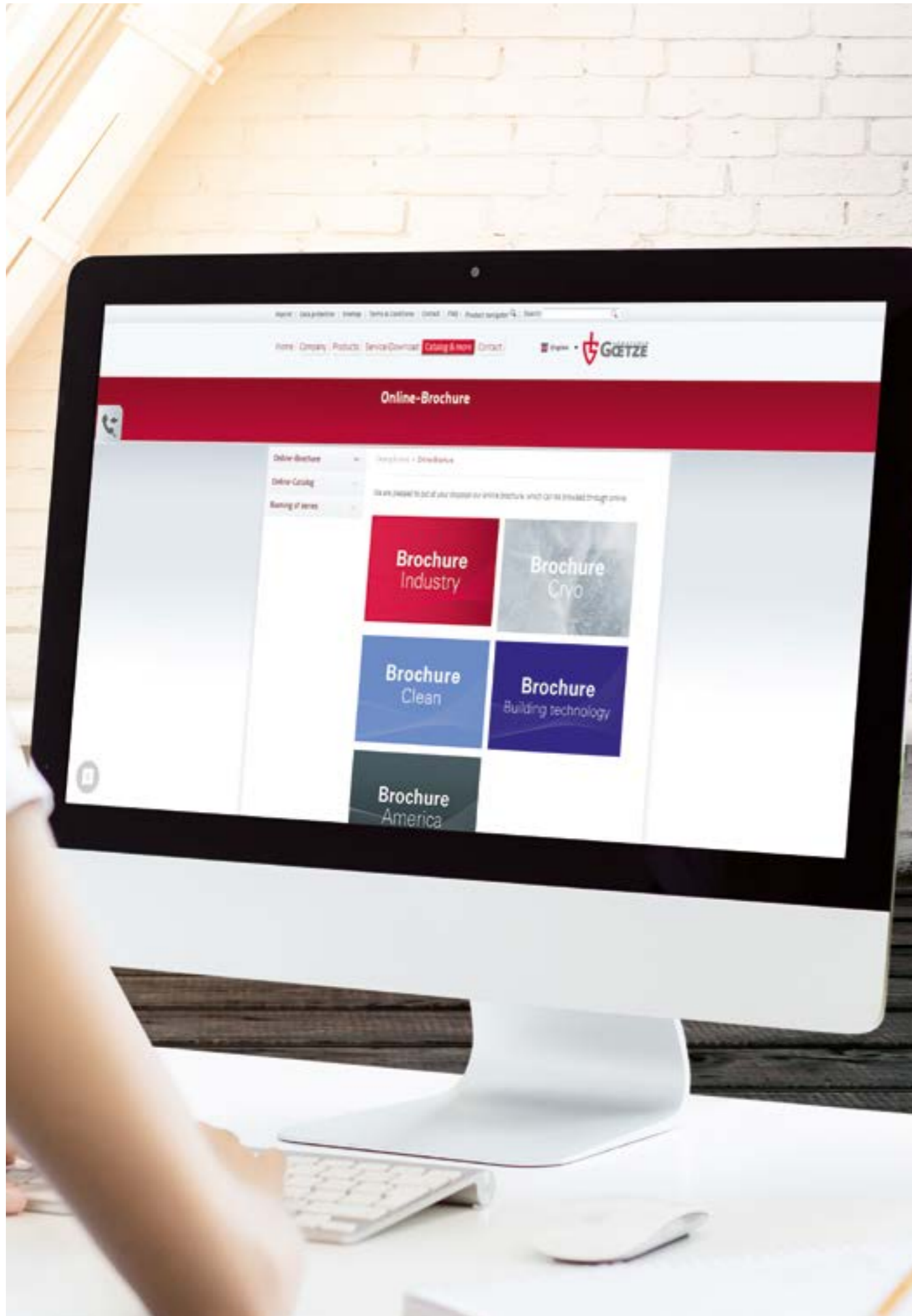

INTERNET SERVICE OF GOETZE

DESIGN AND CALCULATION OF SAFETY VALVES

With the help of our design programme and with the certified discharge number as well as the narrowest flow diameter of our safety valves, the valve suitable for discharging the required volume can be determined according to AD regulation A2-2000, in accordance with the international and European standard DIN EN ISO 4126, API 520 and ASME BPVC-VIII. Our experts offer you competent advice on the optimal and economical sizing of your valve.

3D MODELS AND TENDER DOCUMENTS

We provide free-of-charge our 3D models in various and common formats. On our website you will find them under the section „Download-Service“



MOBILE WEBSITE

Our website is also available in a version optimised for smart phones. As usual, you may find your products simply and easily – also when you are out and about.

Curious? Just take a look!

www.goetze-group.com

NOTES

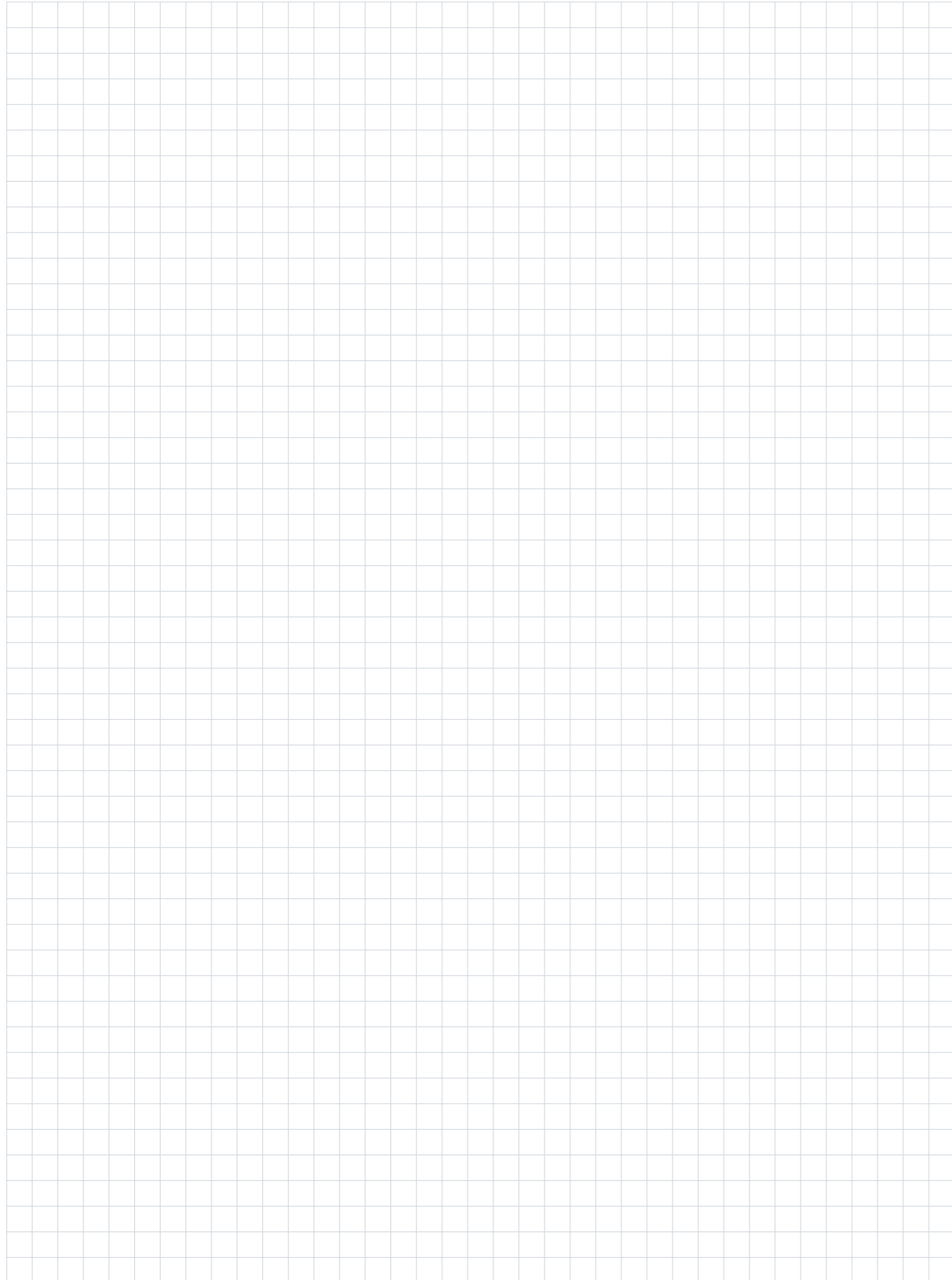

NOTES

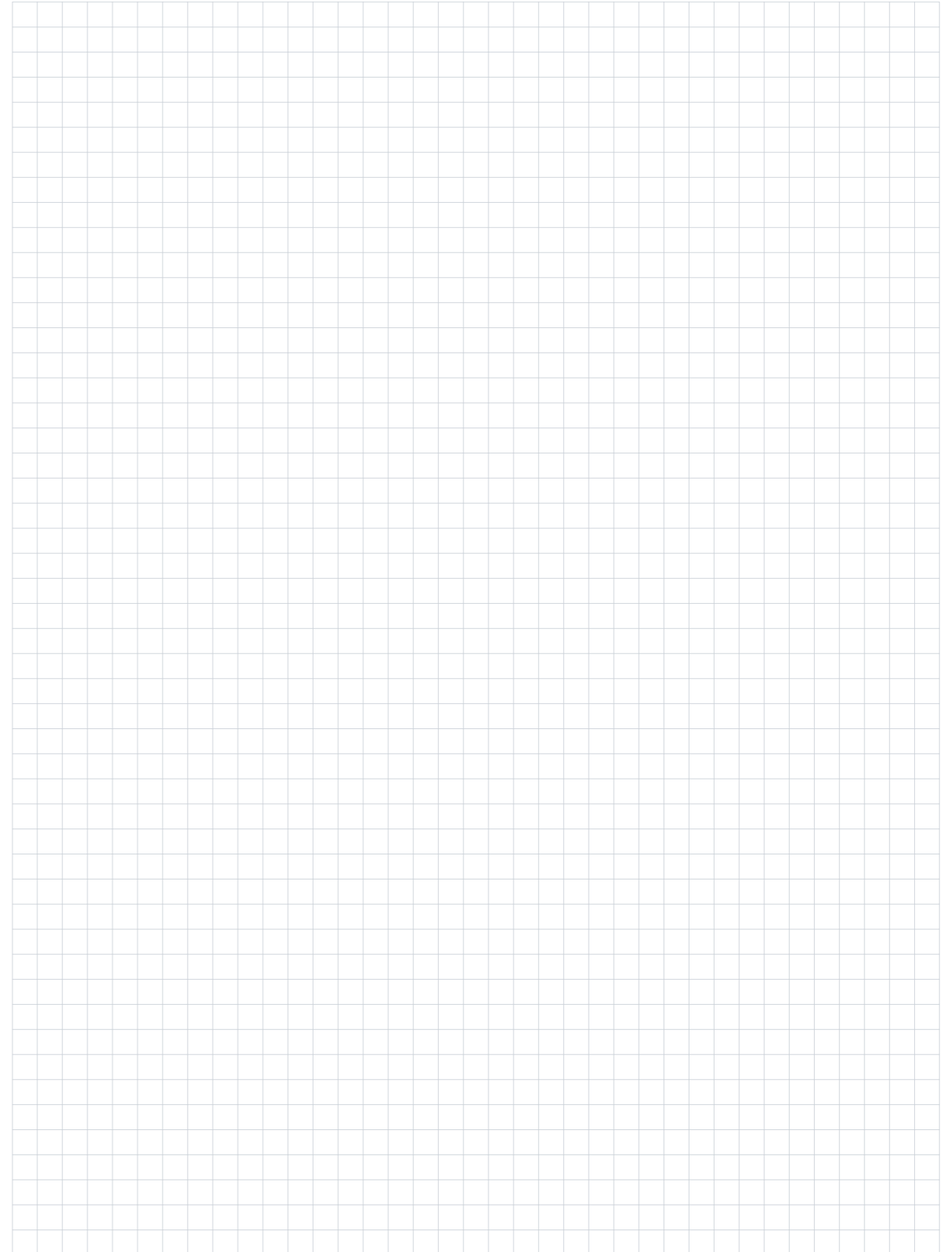

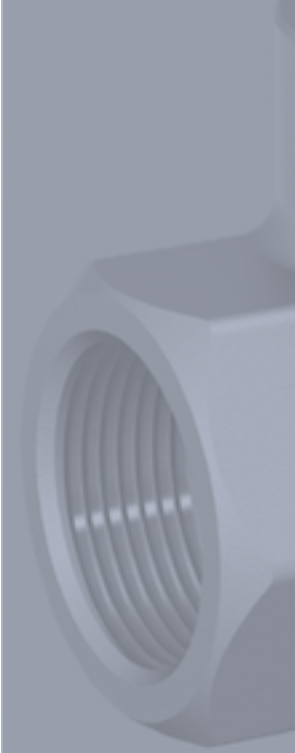

Robert-Mayer-Straße 21
71636 Ludwigsburg

Fon: +49(0)7141 / 4889460
Fax: +49(0)7141 / 4889488

info@goetze-armaturen.de
www.goetze-group.com

Subject to technical modifications. all documents / contents have been produced with utmost care.
However, we accept no liability arising from any printing errors, mistakes etc.